



A completamento dei prodotti presentati nel catalogo, indichiamo di seguito alcuni accessori:

- calotta o pipette coprimorsetti per una valida protezione contro contatti accidentali con i morsetti
- mascherine per la chiusura di forature e cornici per montaggio ad incasso
- sportelli sigillabili per protezioni IP65 e guarnizioni
- sistemi di fissaggio

Here below are listed some accessories to complete the products in the catalogue:

- plastic terminals cover or rubber terminals cover for protection against accidental contacts
- panel cutout covers and frame
- sealable front covers with IP65 protection degree and rubber gaskets
- fixing systems

TIPO - Type

DIMENSIONI - Dimensions

Coprimorsetti - Terminal cover		Codice - Code
Coprimorsetto di protezione per indicatori analogici (di serie su F72... F96... F14...) <i>Protection terminal covers for analog meters (standard for F72... F96... F14...)</i>		9SBMCST
Pipetta in gomma coprimorsetto <i>Rubber terminal covers</i>		9SAMPP
Pipetta in gomma coprimorsetto - Tipo grande (per ingressi 20÷100A) <i>Rubber terminal covers - Large size (for input 20÷100A)</i>		9SAMP
Coprimorsetto per TA <i>CTs terminals cover</i>	TAC003; TAC005; TAC008; TAC010; TAC020; TAC017; TAC071; TAC021; TAC022; TAC032; TAC033; TAC040; TAC050; TAC051; TAC053; TAT061; TAT063; TAT060; TAT081; TAT082; TAT101; TAT127; TAT128; TAT129; TAT165; TAT225	9SBMCTA
	TAT050; TAT090; TAR	9SBMCTA50
	TAT084	9SBMCTA84
	TAT126	9SBMCTA126
	TAT125; TAT064; TAT079; TAT085; TAT106	9SBMCTA125
TAT050...UL; TAT063...UL; TAT081...UL; TAT127...UL	9SBMCTAUL	
Coprimorsetti sigillabile per TA <i>CTs sealable terminals cover</i>	TAC003; TAC005; TAC008; TAC010; TAC020; TAC017; TAC071; TAC021; TAC022; TAC032; TAC033; TAC040; TAC050; TAC051; TAC053; TAT061; TAT063; TAT060; TAT081; TAT082; TAT101; TAT127; TAT128; TAT129; TAT165; TAT225	9SBMCTA
	TAT050; TAT090; TAT128; TAT129; TAT165; TAT225; TAR	9SBMCTA50S
	TAT084	9SBMCTA84S
	TAT126	9SBMCTA126S
	TAT125; TAT064; TAT079; TAT085; TAT106	9SBMCTA125S
Coprimorsetto per TV <i>VTs terminals cover</i>	TTV003	9SBMCTA
	TTV007; TTV010; TTV020; TTV050; TTV100	9SBMCTV
Coprimorsetti sigillabile TV <i>VTs sealable terminals cover</i>	TTV003	9SBMCTA
	TTV007; TTV010; TTV020; TTV050; TTV100	9SBMCTVS

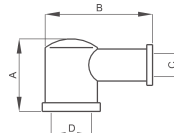
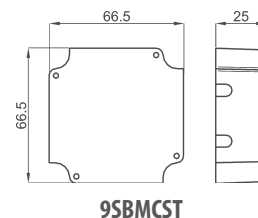

Code	A	B	C	D
9SAMPP	13	36	6,5	11
9SAMP	26	38	7,5	14

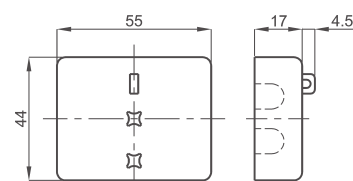

9SBMCTA - 9SBMCTAS
9SBMCTA50 - 9SBMCTA50S
9SBMCTAUL
9SBMCTA84 - 9SBMCTA84S (2 pezzi/pieces)
9SBMCTA126 - 9SBMCTA126S (2 pezzi/pieces)
9SBMCTV - 9SBMCTVS (2 pezzi/pieces)

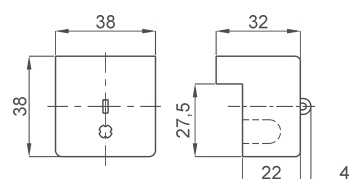

9SBMCTA125 - 9SBMCTA125S

TIPO - Type

DIMENSIONI - Dimensions

Protezioni - Protections		Codice - Code
Sportelli sigillabili con protezione IP65 <i>Sealable front doors with protection degree IP65</i>	72 x 72	9SFCC72SP
	96 x 96	9SFCC96SP
	96 x 48	9SFCC98SP
Guarnizioni di protezione <i>Protection rubber gaskets</i>	48 x 48	9ZSGP48
	72 x 72	9ZSGP72
	96 x 96	9ZSGP96
	144 x 144	9ZSGP14
	96 x 48	9ZSGP98

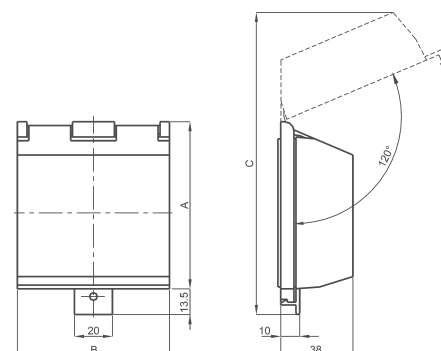

Code	A	B	C
9SFCC72SP	88	80	140
9SFCC96SP	112	103	180
9SFCC98SP	112	56	180

Sistemi di fissaggio - Fixing systems		Codice - Code
Piedini di fissaggio tipo basso <i>Low-type fixing feet</i>	convertitori/transducer; TAT061; TAT063; TAT064; TAT060; TAT079; TAT081; TAT082; TAT085; TAT127	9SAMPDC
Piedini di fissaggio tipo-alto <i>High-type fixing feet</i>	TAC010; TAC020; TAC051; TAC053	9SAMPDL
Cappuccio di protezione per fissaggio TA <i>Protective caps for CT fixing</i>		9SAMCP
Accessorio per fissaggio TAT022 <i>TAT022 fixing accessory</i>		VAT022DIN
Cilindro di connessione per montaggio TA nel punto di giunzione tra due sbarre <i>Connection cylinders to install the CT in the junction point of two busbars</i>		9SAMT...

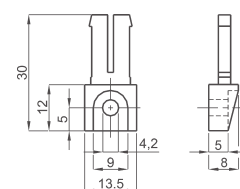

9SAMPDC

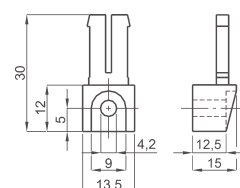

9SAMPDL

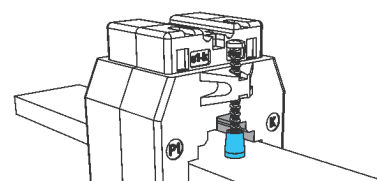

9SAMCP

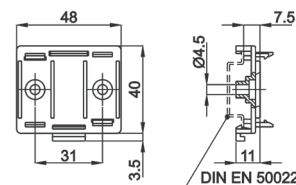

VAT022DIN



9SAMT...

Mascherine e Cornici - Panel cutouts & Frames		Codice - Code
Mascherina di chiusura foro Panel cutout covers	48 x 48	4F48TAP
	72 x 72	4F72TAP
	96 x 96	4F96TAP
	144 x 144	4F14TAP
Cornice per montaggio ad incasso 96x96 indicatori 72x72 Flush mounting 96x96 accessory for 72x72 meters	X72...	4C7296XK
Cornice per montaggio ad incasso 72x72 indicatori modulari 3 mod. DIN Flush mounting 72x72 accessory for modular meters (3 DIN modules)	Q52...	4C5272XK
Cornice per montaggio ad incasso 96x96 indicatori modulari 3 mod. DIN Flush mounting 96x96 accessory for modular meters (3 DIN modules)	Q52...	4C5296XK
Cornice per montaggio ad incasso 96x96 indicatori modulari 4 mod. DIN Flush mounting 96x96 accessory for modular meters (4 DIN modules)	C70Q...	4C70XXXX
Cornice per montaggio ad incasso contatori omologati ENEL Flush mounting frame Kit for Energy meter approved by ENE	CSEZMD...	4CSEZMDK

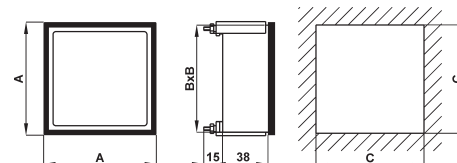

Code	A	B	C
4F48TAP	48	44	45
4F72TAP	72	67	68
4F96TAP	96	91	92
4F14TAP	144	137	138

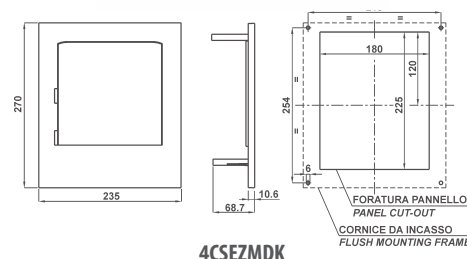

4CSEZMDK



4C7296XK

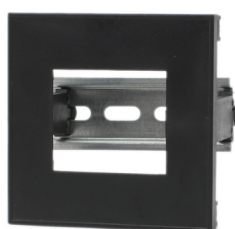

4C5296XK

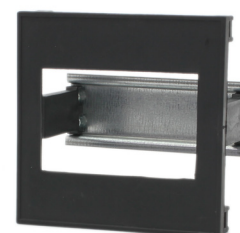

4C70XXXX